

PILZ_2_D(500)

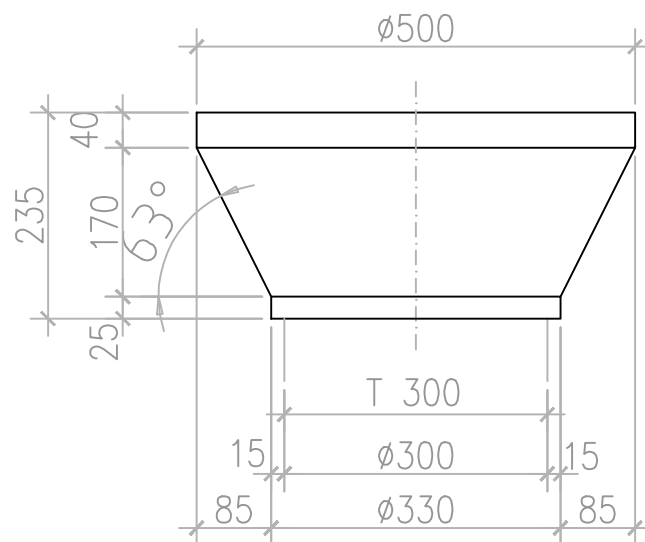
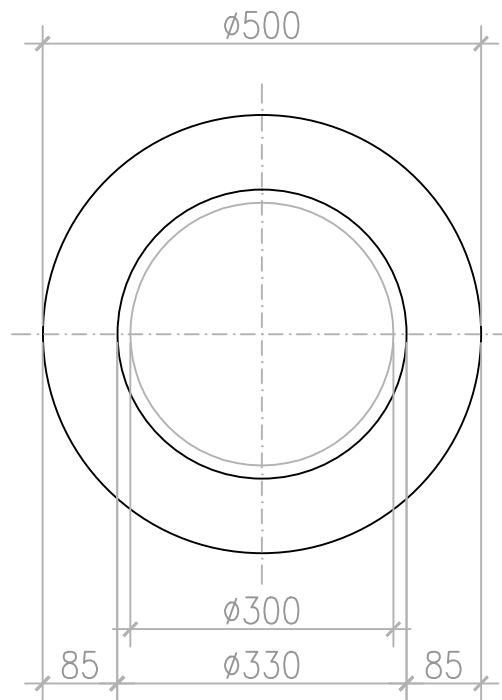

34 Liter
85 kg

ANLAGENUMMER: 2